

Voice of Saturn Synth Assembly Instructions

For PCB v1.03 06/20/2008

Assembly Instructions v8 09/20/2009

1. Recommend Tools and Supplies:

- Soldering Iron and Solder: A 15 Watt iron will may get the job done, but it'll be easier with a 25 or 35 Watt iron. The larger pot and switch connections can draw a lot of heat. Don't lose sleep purchasing your first iron; any cheap RadioShack one will do. We like small chisel or screw driver shaped tips (say 1/16th of an inch wide), but personal preference plays a big role. The goal is to use a tip that's about the same size as the pad you're soldering. This way you get you get as much surface area contact as possible (better for heat transfer) but are still small enough to avoid touching neighboring pads. For solder, we recommend .02 or .031" diameter, rosin cored flux, tin-lead solder, either 63/37 or 60/40, whatever's cheaper. See our [soldering guide](#) for explanations. Lead-free solder is a little bit harder to use since it "wets" metal somewhat slower and has a slightly higher melting point. If your kit has sat on the shelf for a while (a year), some steel wool or a pink eraser is useful to remove oxidation from the components and board before starting.
- Needle Nose Pliers: Used to clinch or bend component leads, help remove components, and in this kit, remove metals stubs from the pots and also tighten nuts.
- Helping Hands: Two aligator clips on a heavy base that are useful for holding wires while you solder them.
- Flush Cutters: Used to trim leads close ("flush") to the board.
- Solder Sucker or Solder Wick: Used to remove solder.
- Clamp: A table top will be fine for most of the job, but a clamp can be handy, especially when removing components.
- Multimeter: To check your work.
- 22 Guage stranded wire: The big component we don't supply is wire to connect the circuit board connections to the pots and switched. We recommend 22 guage stranded wire, since solid wire is more likely to break while being bent back and forth during installation. The more colors, the easier to keep track of things.
- Wire Strippers:
- Screwdriver: Either phillips or regular will do for putting together the case.

2. Add components to the PCB (Printed Circuit Board):

note: these pics are for v1.02 of the board. v1.03 will have a few more components moved to the board, so some of the pics will look slightly different, but the instructions should still apply overall.

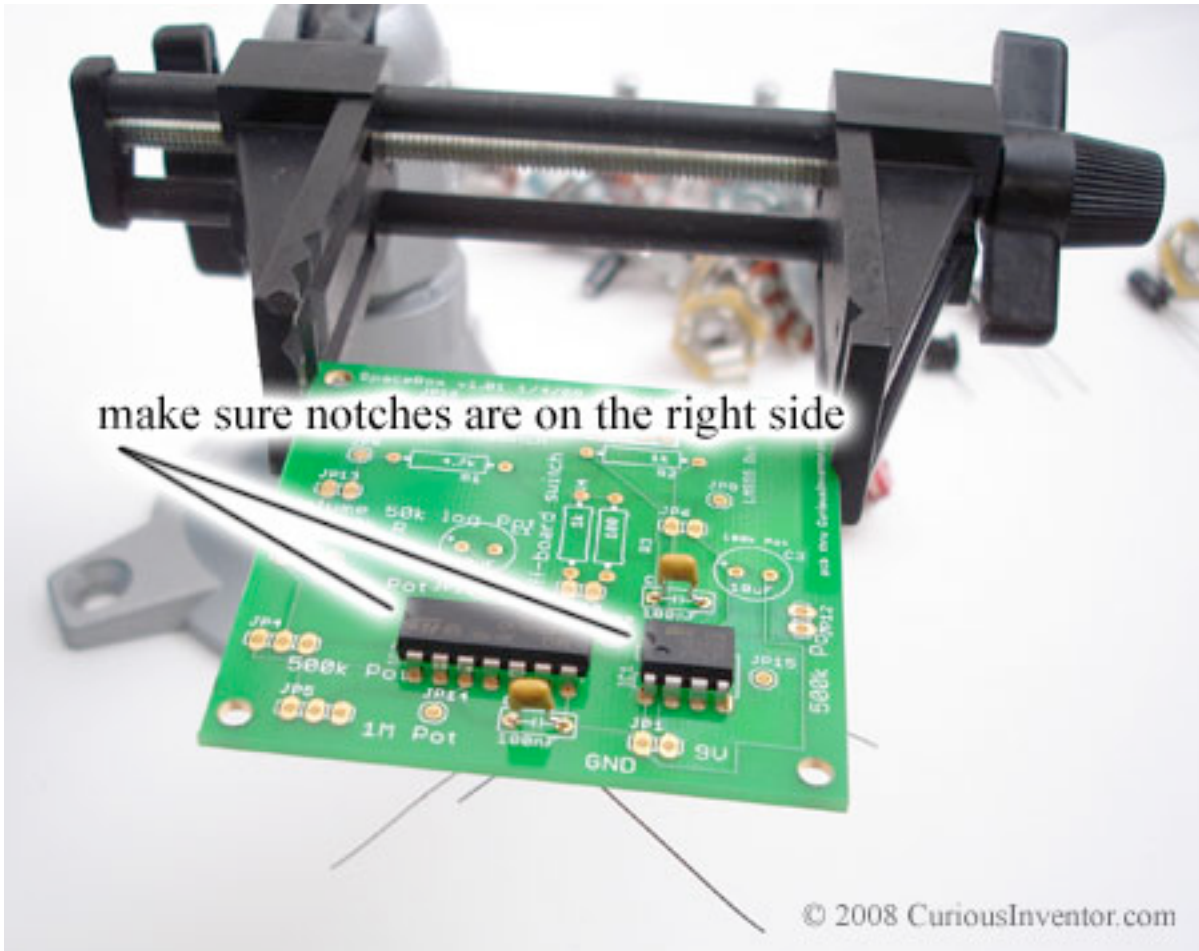

First, add the ICs making sure to line up the notches on the chips with the markings on the pcb.

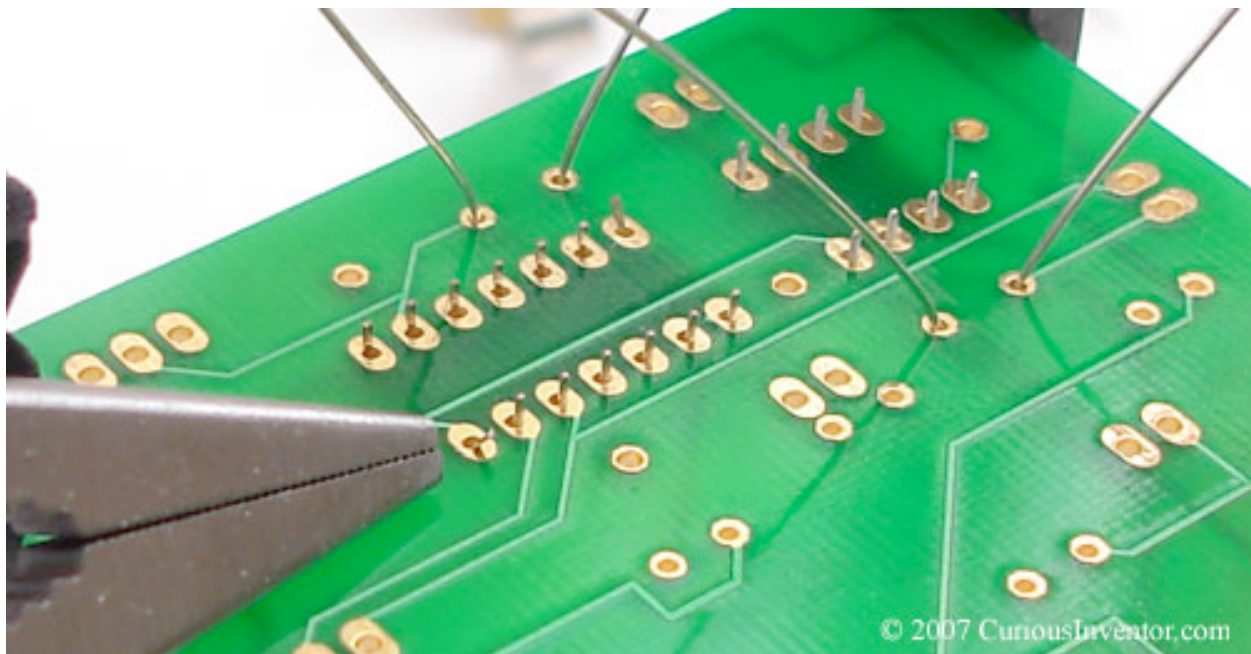

To keep components in place while you solder them, clinch (bend / splay) the leads outwards. On the IC, do this for two opposite corners. This is actually what automated machines do to keep chips in place while the boards are run over fountains of liquid solder (wave soldering).

3. Soldering:

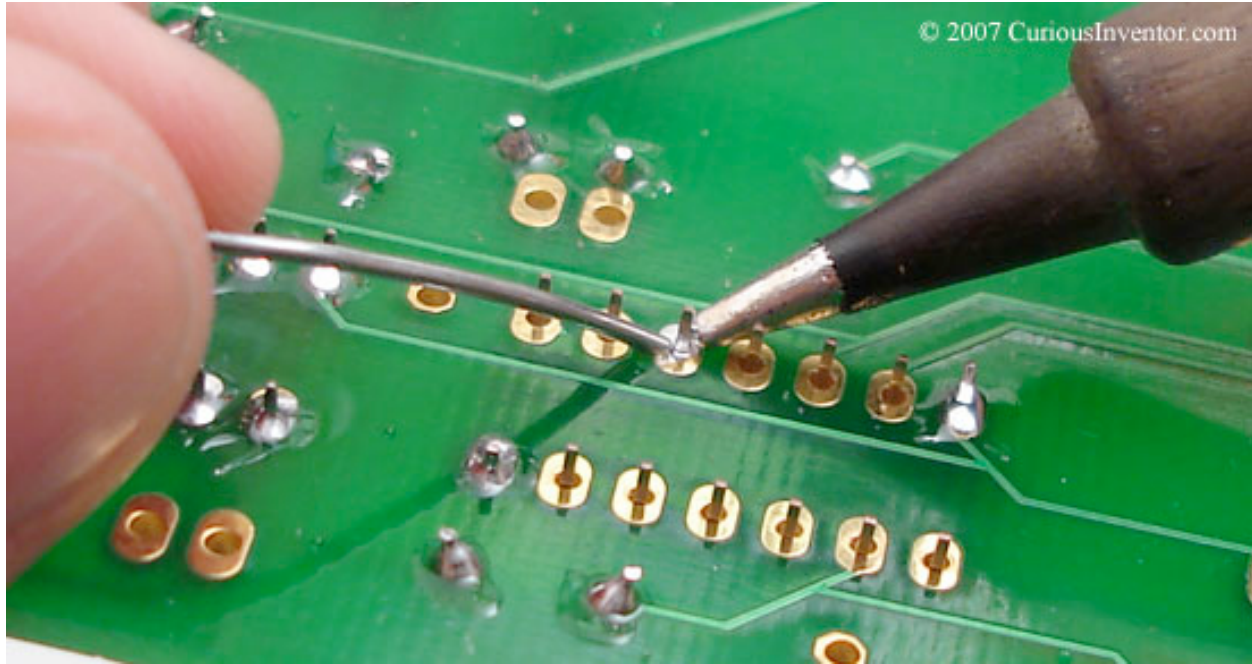

Tin the tip, or in other words, add a bit of solder to the tip, first. This small amount of solder forms a "heat bridge" to help conduct heat from the tip to the pad and component lead. When you first contact the parts with the iron tip, it's helpful to first place some solder in between the iron and components, then melt solder on the the side opposite from the iron tip. This ensures that the component is hot enough to bond to the solder, and also helps to spread out the solder as it will run towards the heat source.

On ICs, it's a good idea to solder every other pin (and then fill in the gaps) to reduce the risk of overheating the component.

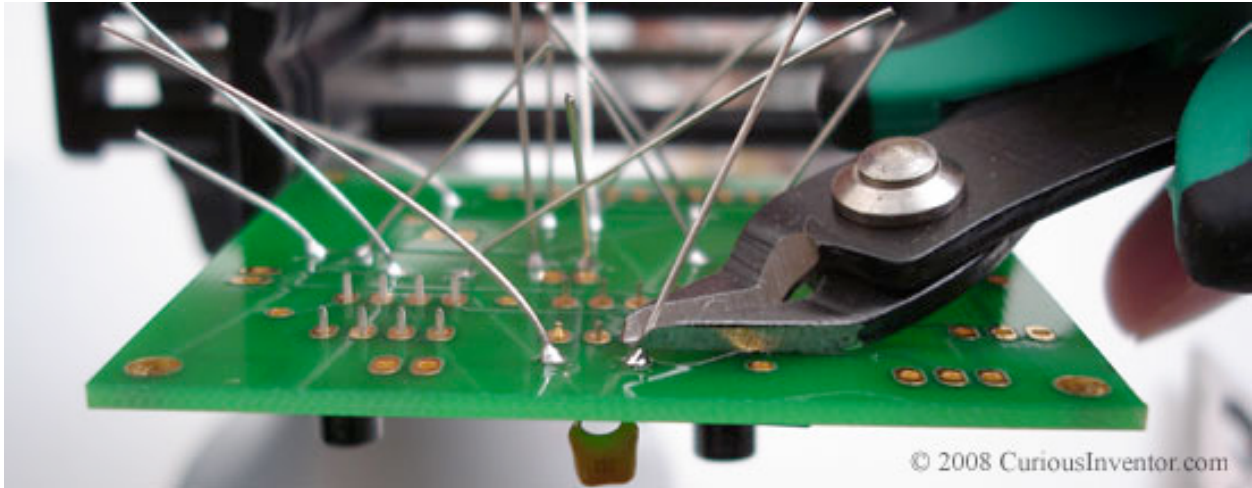

Cut off the leads as you go with flush cutters. Watch out for flying leads; safety glasses are actually not over-precious for this, although we generally just hold the lead with fingers to keep it from flying off.

4. Resistors:

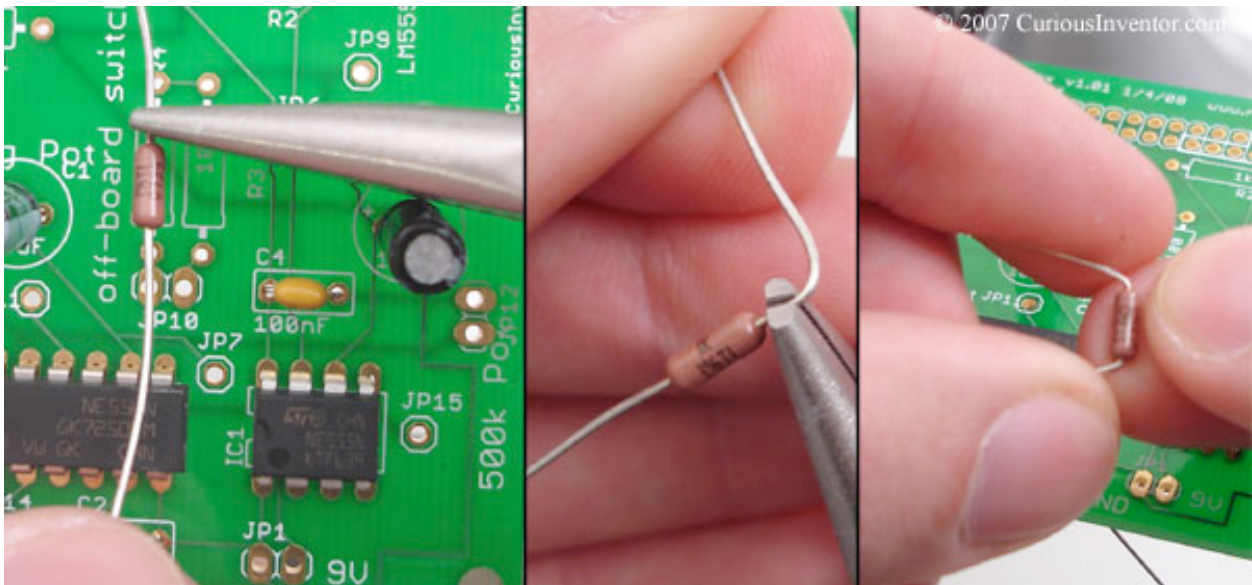

Pre-bend the leads before inserting to keep from damaging the board and resistor (not doing this isn't the end of the world). First hold the resistor above its position, then hold the lead with pliers next to where the bend should go and then fold over the lead. You can also wing it with fingers. Another benefit of using pliers is that you prevent the joint between the resistor body and lead from being stressed. Resistors and most other components should be inserted as far as possible; this means lying flat for resistor. It's convention to install resistors so their code can be read left to right in the same direction as the silk screen (tolerance band on the right).

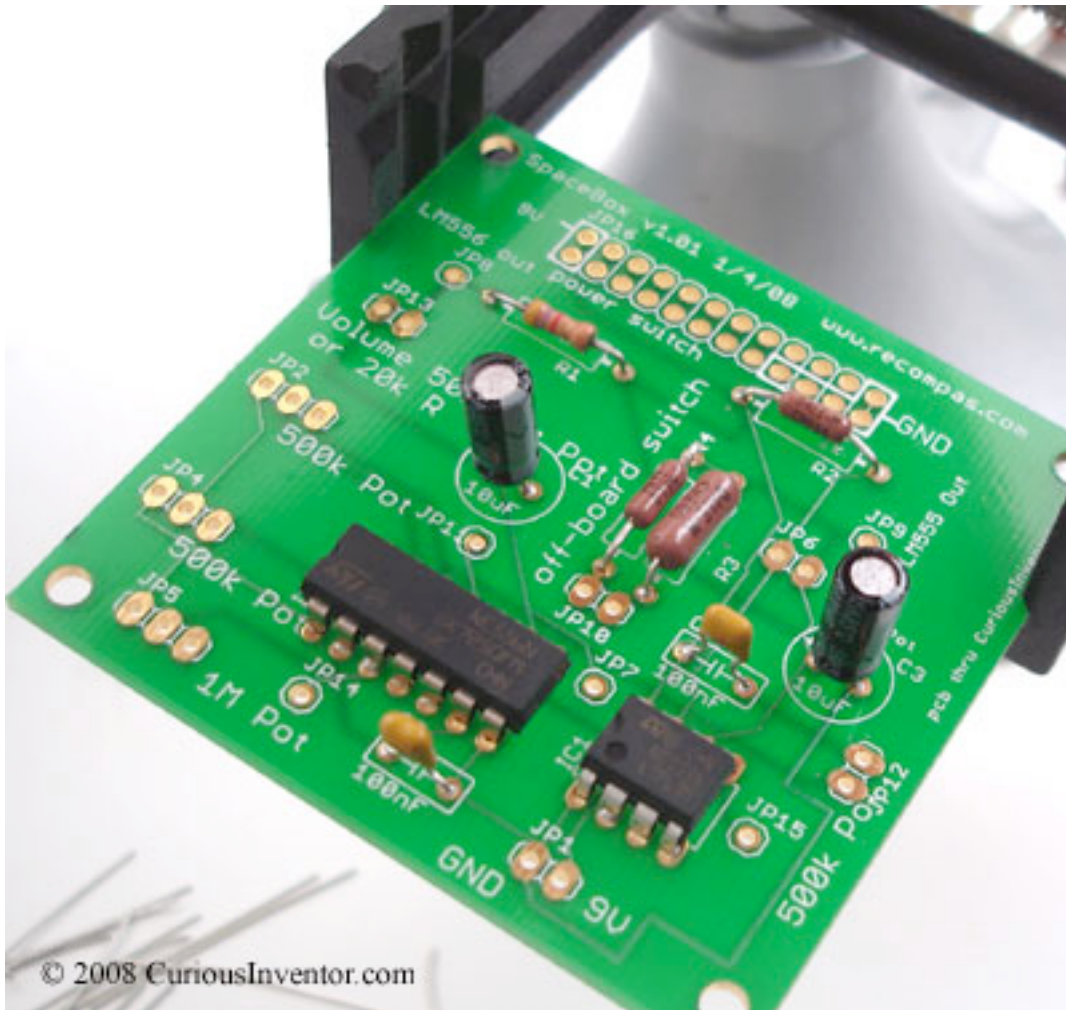

Finished circuit board.

5. Installing Pots, Switches, LEDs and Audio Jacks:



First break off the anti-rotation tab with pliers, then install like the following picture shows:
 Note: if your circuit board says v1.02, use [this connection diagram](#). The following diagram is for v1.03 boards and up (a few components were moved to the pcb).

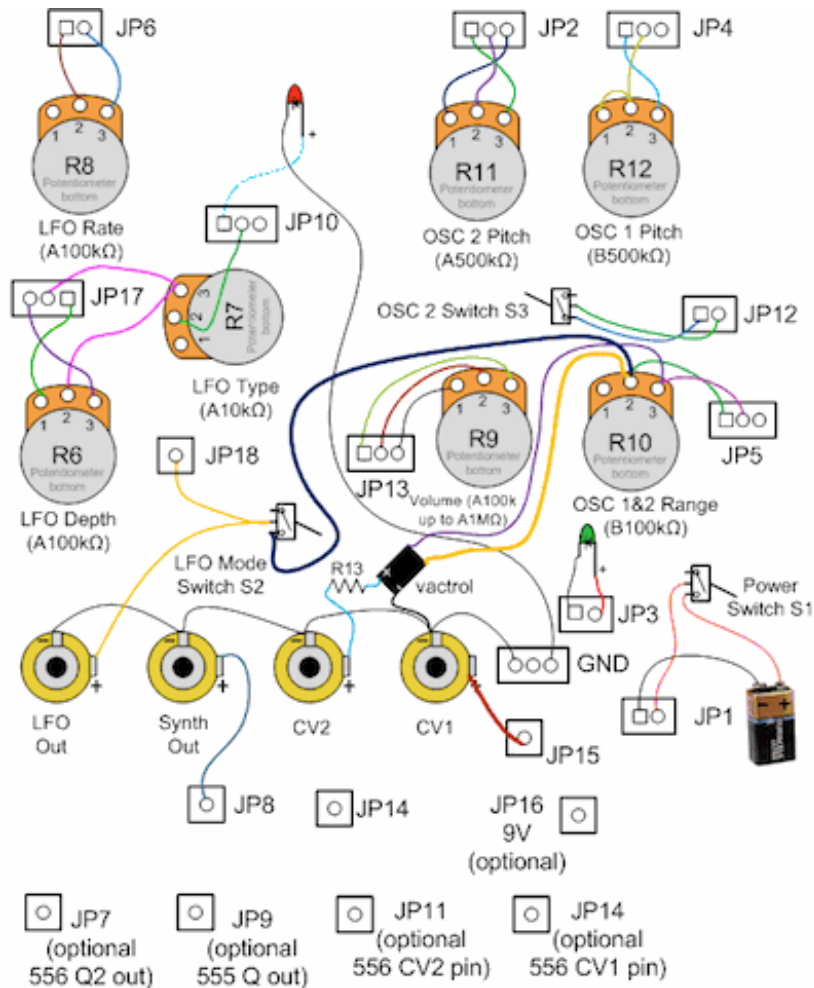

- JP7 (optional 556 Q2 out)
- JP9 (optional 555 Q out)
- JP11 (optional 556 CV2 pin)
- JP14 (optional 556 CV1 pin)



Install the LED holders from the outside, then press the LEDs into them from the inside until they snap in place.



6. Wiring up all the components to the board:

Once you have all the components in place, cut about 8 inch sections of wire and start connecting the PCB to the knobs and switches.

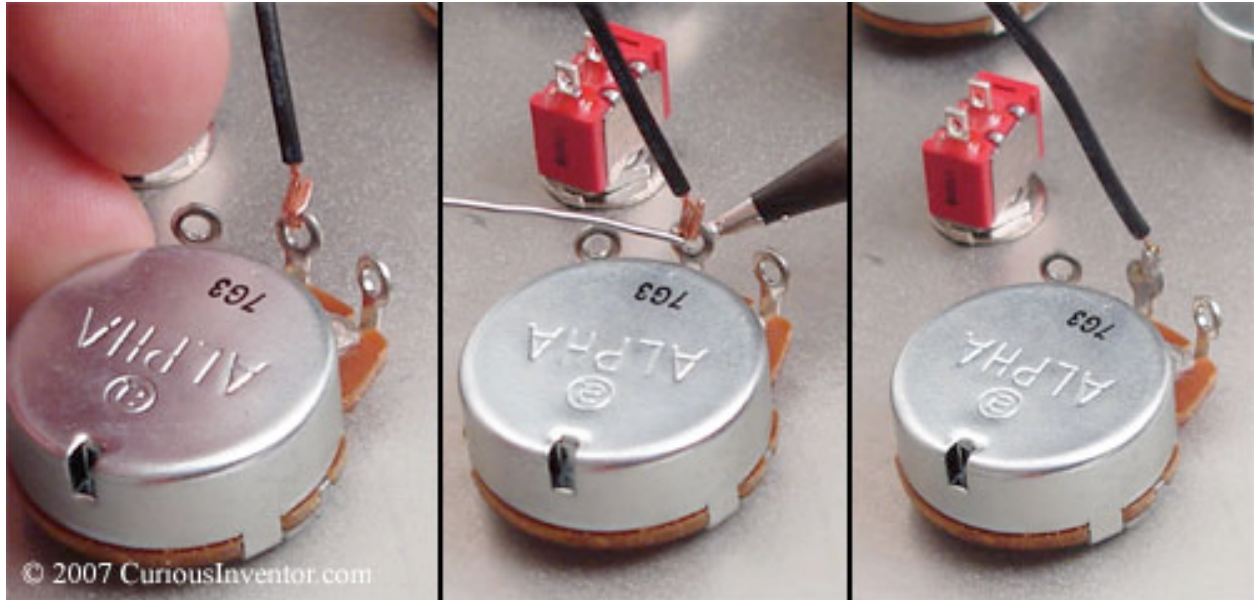

First loop the wire through and bend it to hold it in place, then heat the joint from one side and apply solder to the other. Again, it will help to put a bit of solder between the iron tip and connection to act as a heat bridge.

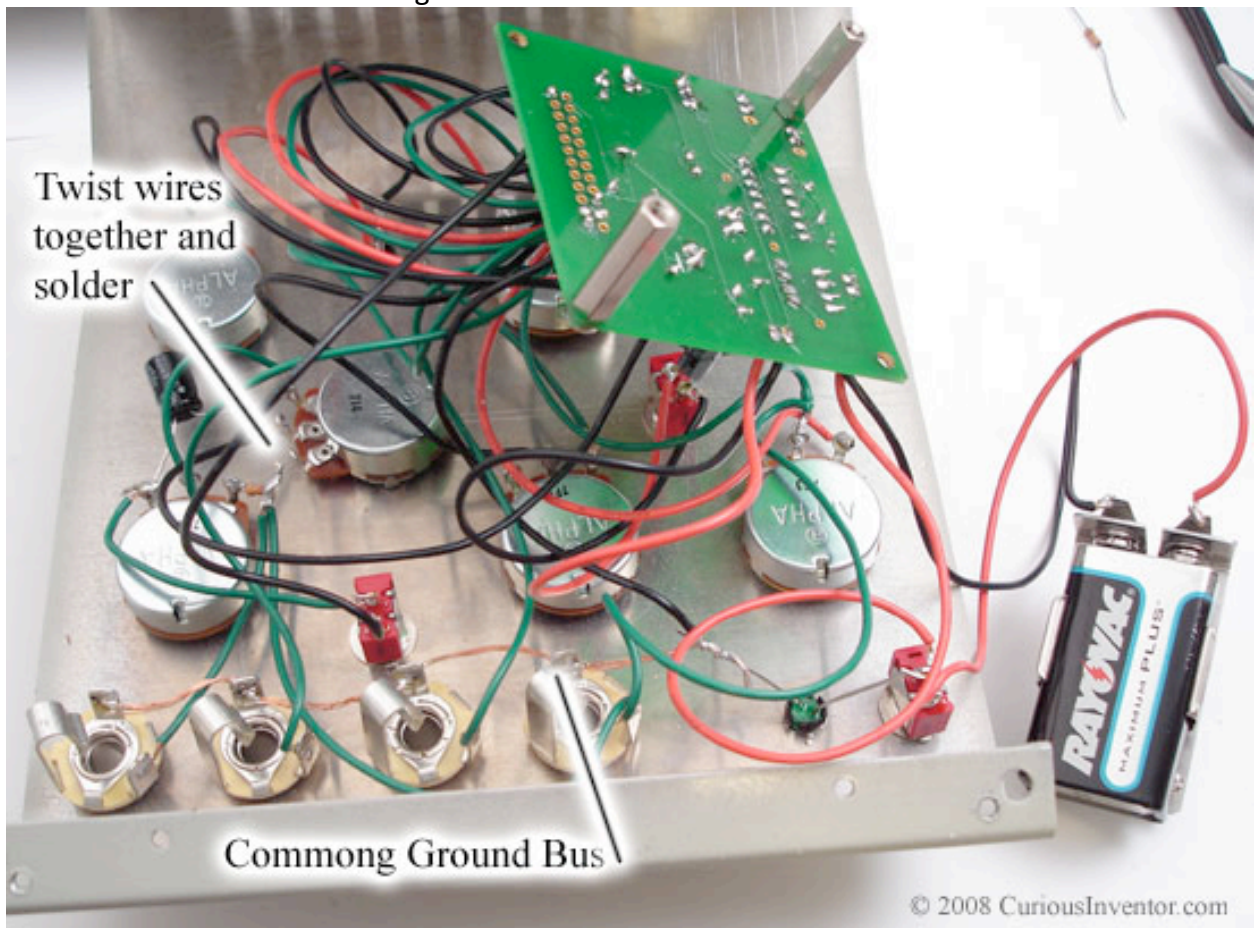

Be sure to include the capacitor and resistor as shown in the diagram. Where multiple wires meet (at the resistor for instance), twist the wires together and then add solder. Cover exposed wires with electrical tape. One tip is to use one continuous strip of wire to connect the grounds of all the audio jacks (as shown).

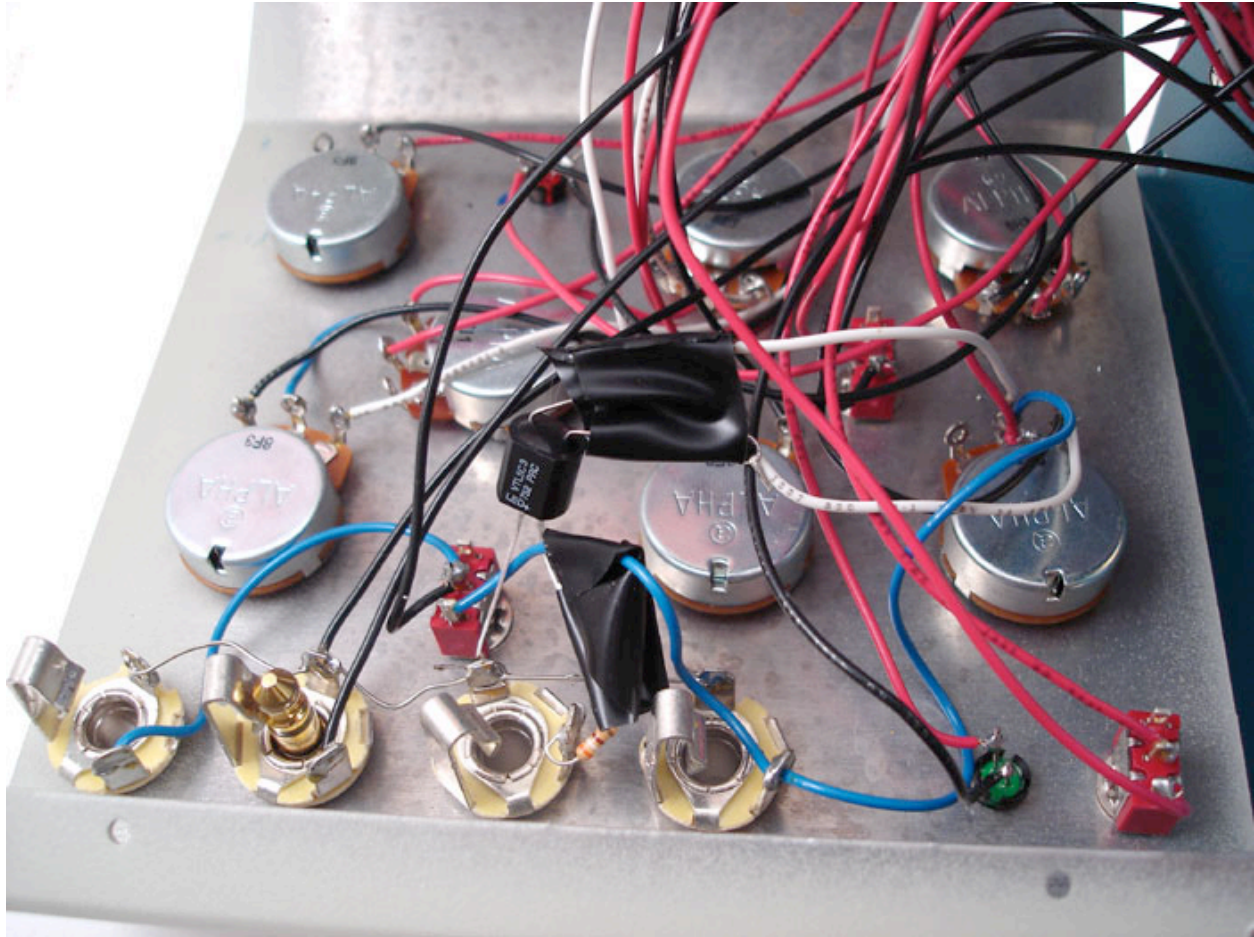

Install the vactrol and 390ohm resistor directly inside the case. Use electrical tape or heat shrink tubing to protect the wires. Make sure the positive side of the vactrol is attached to the positive Jack terminal. See the connection diagram for more clarification.

Finally solder wires to the battery holder, attach the standoffs to the pcb and screw together the case.



When you first turn it on, the green light should be solid and the red should blink slowly if the LFO Rate is all the way to the left (counter-clockwise). Some knob arrangements don't product any sound at all; set the knobs and switches as shown above to get something.